



Full PROGRAMMABLE control gear up to 40W. IP67

eSMART

STELARIA®

0...10V

DALI

ORC < 5%



SELV

IP67 and eSMART technology benefits

ELT electronic control gears with IP67 ingress protection are the perfect choice for those applications in which it is necessary to ensure greater protection against aggressive environments, greater exposure to external atmospheric agents or simply to provide greater robustness to the lighting system.

iLC PRO-IP67 series is equipped with eSMART technology, full programmable functionalities and regulation methods, providing total design flexibility to the lighting system and perfectly adapting the luminaires to any application and surroundings where they are to be installed.

Due to their flexibility, robustness, long lifetime and connecting possibilities, iLC PRO-IP67 series with eSMART technology is the ideal control gear for street lighting solutions.

Features

- Class II, independent control gear. Ingress Protection IP67
- Suitable for installation in Class I and Class II luminaires
- Wide input voltage range
- High power factor
- Low total harmonic distortion
- Low standby power consumption
- Low output ripple current
- High quality light without flickering
- Wide operating window
- Configurable functionalities for an optimal lighting system design:
 - Adjustable output current (AOC)
 - LED module thermal protection (MTP)
 - LED module constant lumen output (CLO)
 - LED module end-of-life alarm (EOL)
 - Programmable start-up time (PST)
 - Monitoring parameters and events
- Different regulation methods can be selected, adapting each lighting point to the installation requirements:
 - DALI
 - 1-10V / 0-10V
 - ActiDIM: stand-alone and dynamic dimming system that adapts to night hours
 - Parking mode: light regulation via presence detectors
 - ActiDIM Parking: combines stand-alone dimming with presence detectors
 - LineSwitch: regulation by control line
 - MainsDIM: regulation varying the mains voltage
 - ON/OFF: no regulation
- Wide output current regulation range
- Compatible with the STELARIA™ remote street lighting management system
- Short circuit, overload and open circuit protection
- Control gear thermal protection
- Protection against mains voltage variations and power surges
- Excellent thermal performance and extensive working temperature ranges
- Lifetime up to 100.000 hours

Applications

- Street lighting
- Road lighting
- Architectural lighting
- Sport facilities lighting
- Industrial lighting
- Tunnel lighting



ELECTRICAL DATA

Input parameters

Nominal input voltage	180...277 Vac
Permitted input voltage range	162...305 Vac
Brownout input voltage	115 Vac
Brown-in input voltage	150 Vac
Input frequency	50...60 Hz
Input current ⁽¹⁾	0,028...0,26 A
Power factor ⁽²⁾	0,98
Total harmonic distortion THD ⁽³⁾	< 10 %
Typical efficiency ⁽⁴⁾	Up to 90 %
Standby power consumption	< 0,5 W
Typical leakage current	< 0,5 mA
Inrush current (peak / width)	25 A / 195 us
DALI voltage range	9,5...305 Vac/dc
DALI consumption	< 2 mA
1-10V / 0-10V voltage range	-20...20 Vdc
1-10V / 0-10V potentiometer	560 kΩ
1-10V / 0-10V maximum output current	120 μA
0-10V control signal to enter standby	Short circuit / 0 Vdc
0-10V control signal to exit standby	> 1,5 Vdc

(1) Depending on the connected load, the output current adjustment, the regulation point and the mains voltage value

(2) See PF vs. load graph

(3) See THD vs. load graph

(4) See efficiency vs. load graph

Output parameters

Maximum output power	40 W
Output type	Constant current
Dimmable	✓
Dimming method	Amplitude modulation
Dimming range ⁽⁵⁾	7...100 %
Configurable output current range	70...1050 mA
Non-dimmable output current range	70...199 mA
Dimmable output current range	200...1050 mA
Output current tolerance	± 5%
Output ripple current (ORC)	< 5 %
Output voltage range ⁽⁶⁾	15...80 Vdc
Maximum output voltage (open load)	< 120 Vdc (SELV)
NTC terminal input voltage ⁽⁷⁾	Not permitted

(5) Minimum current 70mA

(6) See operating window

(7) Risk of failure

Operating window

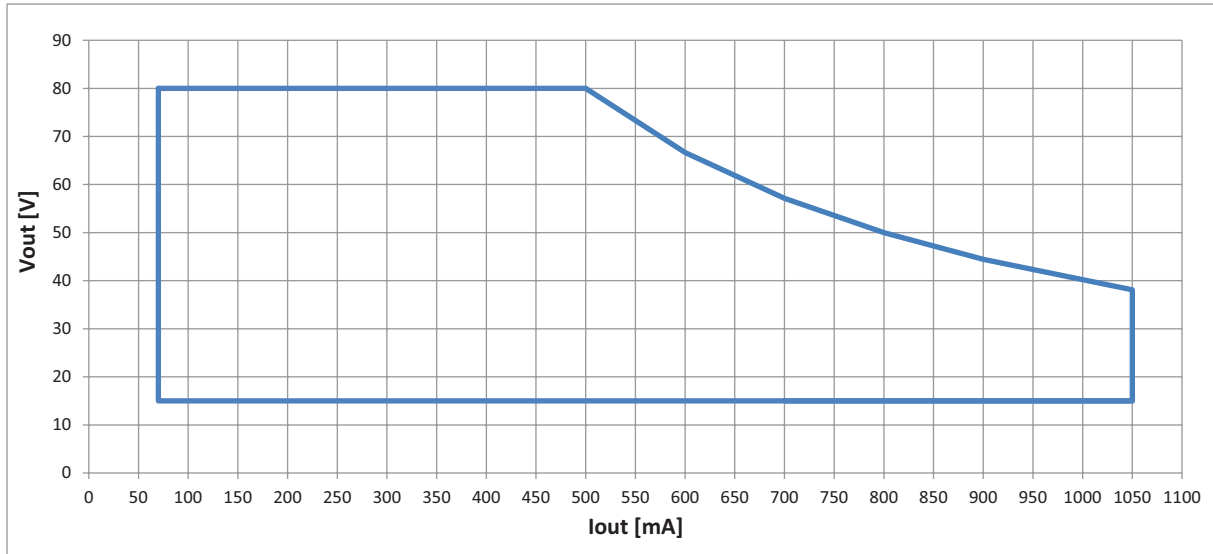

Adjustable output current (AOC)	Regulation	Minimum output voltage	Maximum output voltage	Minimum module power	Maximum module power
mA		V	V	W	W
70...199	ON/OFF	15	80	$\frac{AOC (mA) \times 15}{1000}$	$\frac{AOC (mA) \times 80}{1000}$
200...500	✓	15	80	$\frac{AOC (mA) \times 15}{1000}$	$\frac{AOC (mA) \times 80}{1000}$
501...1050	✓	15	$\frac{40 \times 1000}{AOC (mA)}$	$\frac{AOC (mA) \times 15}{1000}$	40

Electrical insulation

	Mains	DALI	0-10V / 1-10V	Functional earth	LED module / External NTC / STELARIA	Accesible parts
Mains	X	Basic	Basic	Double	Double	Double
DALI	Basic	X	Basic	Double	Double	Double
0-10V / 1-10V	Basic	Basic	X	Double	Double	Double
Functional earth	Double	Double	Double	X	Double	Double
LED module / External NTC / STELARIA	Double	Double	Double	Double	X	Double
Accesible parts	Double	Double	Double	Double	Double	X

According to EN 61347-1 and EN 61347-2-13

Graphs

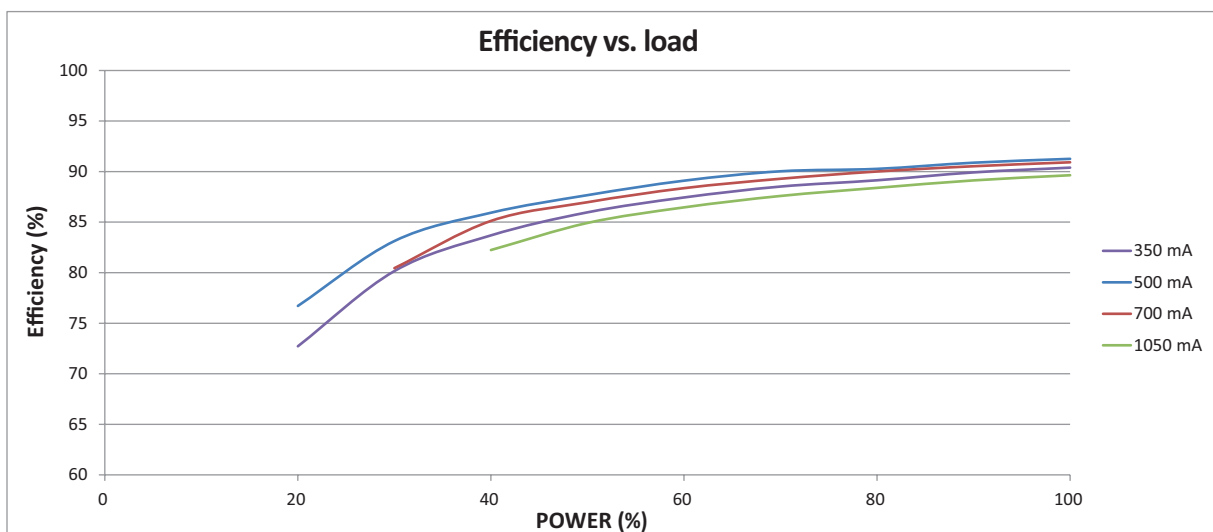
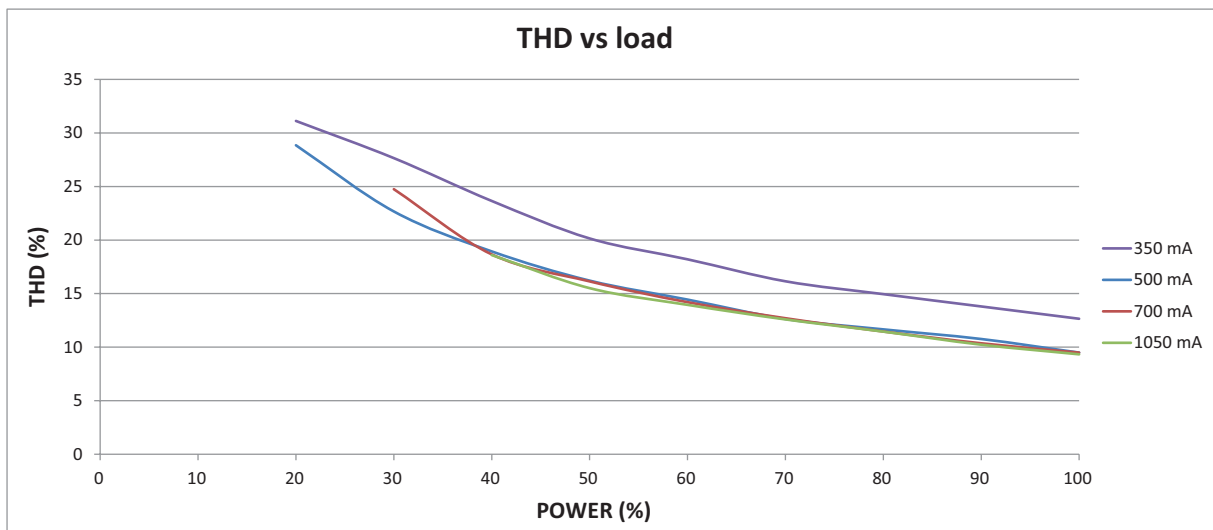
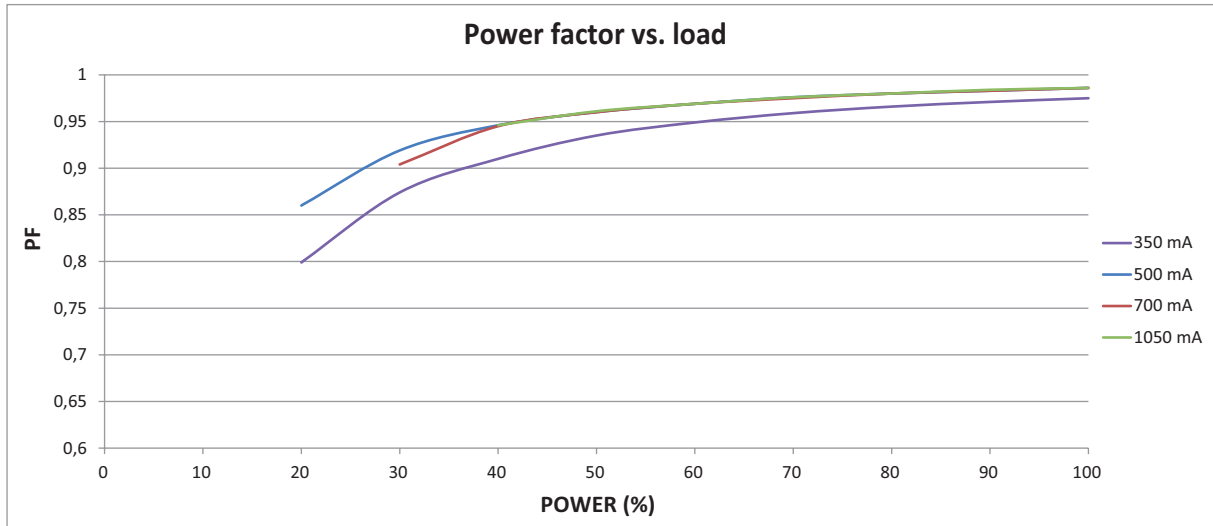

Typical values measured for a representative sample of standard manufacturing with a stabilised supply source at 230V/50Hz. These values are not intended to be a specification.

THERMAL AND LIFETIME DATA

Maximum case temperature at tc point (tc max)	80 °C
Lifetime case temperature (tc)	See table
Minimum ambient temperature (ta min)	-40 °C
Maximum ambient temperature (ta max)	65 °C (@1050mA, tc max)
Maximum case temperature (under failure conditions)	110 °C

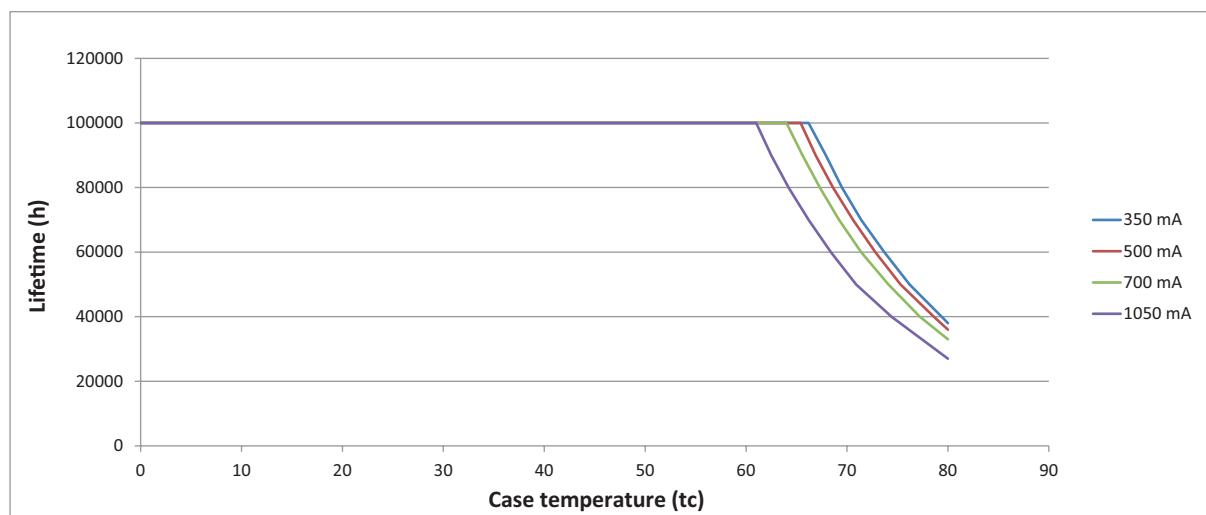

		50.000h	60.000h	70.000h	80.000h	90.000h	100.000h
350mA	tc (°C)	76,00	74,00	71,00	69,00	67,00	66,00
	ta (°C)	65,00	63,00	60,00	58,00	56,00	55,00
500mA	tc (°C)	75,00	73,00	71,00	69,00	67,00	65,00
	ta (°C)	61,00	59,00	57,00	55,00	53,00	51,00
700mA	tc (°C)	74,00	71,00	69,00	67,00	65,00	64,00
	ta (°C)	60,00	57,00	55,00	53,00	51,00	50,00
1050mA	tc (°C)	71,00	69,00	67,00	65,00	64,00	62,00
	ta (°C)	55,00	52,00	50,00	48,00	47,00	45,00

PROTECTIONS

Short circuit	✓
Open circuit	✓
Overload	✓
Low load	✓
Thermal	✓
Mains voltage out of range	✓
Surge	✓
Hot wiring	✗

Control gear response to failure conditions

Failure condition	Control gear response	Recovering
Short circuit	Flickers	Automatic recovering
Open circuit	Safety mode	Automatic recovering if sporadic events Not automatic recovering if consecutive events
Overload		
$< V_{out\ max} + 8\%$	Normal operation with over temperature	Automatic recovering
$\geq V_{out\ max} + 8\%$ $< V_{out\ max} + 12\%$	Normal operation during 70s before safety mode	Not automatic recovering
$\geq V_{out\ max} + 12\%$ $< V_{out\ max} + 15\%$	Normal operation during 10s before safety mode	Not automatic recovering
$\geq V_{out\ max} + 15\%$	Safety mode	Automatic recovering if sporadic events Not automatic recovering if consecutive events
Low load	Flickers	Automatic recovering
Overtemperature⁽⁸⁾		
$t_c\ max + 5\ ^\circ C$	25% power reduction	Automatic recovering at $t_c\ max - 6\ ^\circ C$
$t_c\ max + 7\ ^\circ C$	Safety mode	Automatic recovering at $t_c\ max - 6\ ^\circ C$
Mains voltage out of range		
$< 162V$ $> Brown\ out$	Normal operation with over temperature	Automatic recovering
$< Brown\ out$	Switch off	Switch on at mains voltage $> brown\ in$
$> 305V$	Operation under stress ⁽¹⁰⁾ Risk of failure	Automatic recovering
Surge protection⁽⁹⁾	6kV/3kA differential mode (L-N) 8kV common mode (L/N-Earth)	
Hot wiring	Not allowed Risk of failure	

Safety mode: the control gear disconnects the output in this mode.

Not automatic recovering: switching off mains voltage for a few seconds is required.

(8) See chart below

(9) According to EN 61547

(10) Withstands 380V up to 2 hours

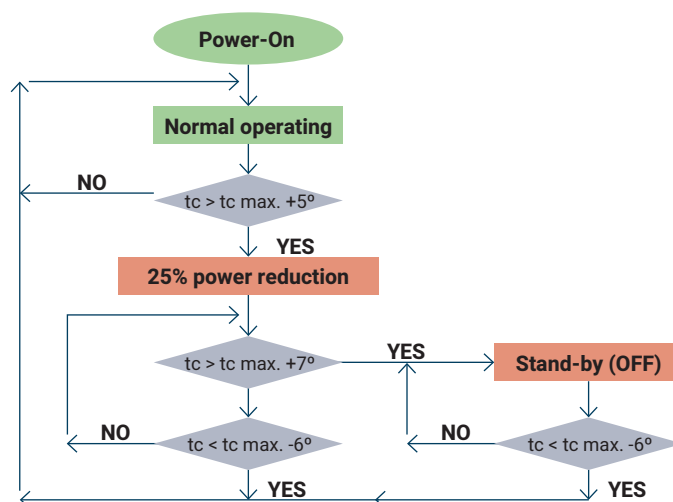

FUNCTIONALITIES

	Available	Factory default configuration
Adjustable output current (AOC)	✓	700 mA
Module thermal protection (MTP)	✓	Disabled
Constant lumen output (CLO)	✓	Disabled
End-of-life module alarm (EOL)	✓	Disabled
Programmable start-up (PST)	✓	Disabled
Monitoring parameters	✓	Always enabled

REGULATION METHODS

	Available	Factory default configuration
ON/OFF	✓	Disabled
DALI	✓	Disabled
1-10V	✓	Disabled
0-10V	✓	Disabled
ActiDIM	✓	Enabled
ActiDIM with tourist mode	✓	Disabled
Parking mode (Corridor mode)	✓	Disabled
ActiDIM with Parking mode (Corridor mode)	✓	Disabled
LineSwitch	✓	Disabled
MainsDIM	✓	Disabled
Compatible version with STELARIA™ Remote wireless management system	✓	Disabled

ActiDIM default configuration

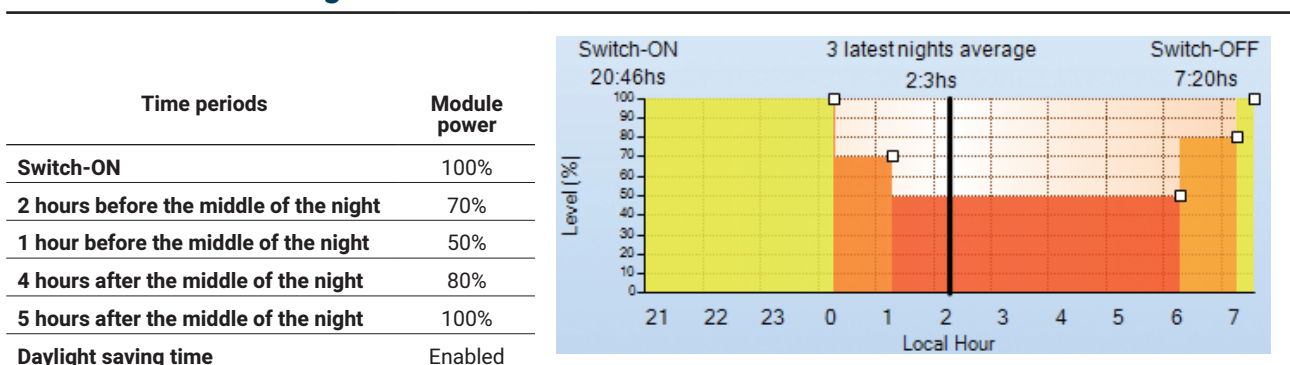

Please, refer to the user guide for further information about eSMART technology

CONNECTIONS AND WIRING

Mains cable	H05RN-F / 3x1 mm ² (brown, blue, yellow-green)
DALI cable	
1-10V / 0-10V cable	
NTC cable	H05RN-F / 2x1 mm ² (brown, blue)
LED cable	
Wire ends	Tinned
Maximum cable length to LED module	2 m
Maximum cable length to external NTC	0,6 m

Please, refer to the user guide for further information about control gear installation

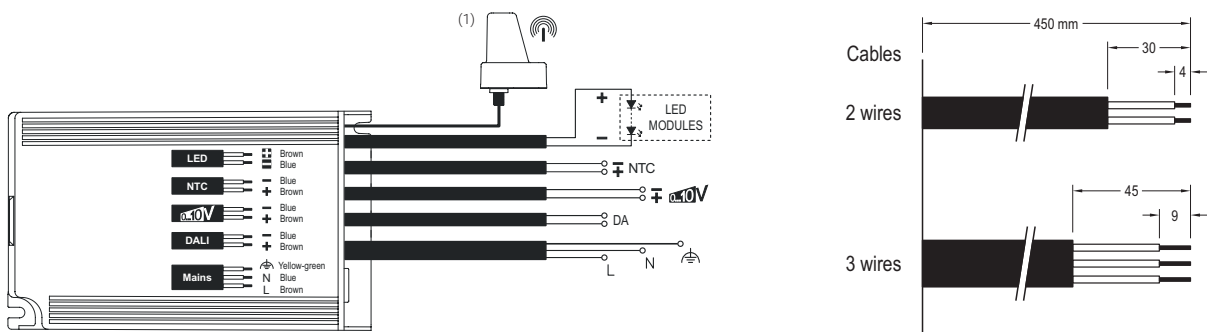

(1) Optional connection with STELARIA™ Remote Wireless Management System

PROTECTIVE SWITCHES

Inrush current and MCBs

Inrush current peak	25 A
Inrush current width	195 us
Control gears / MCB 16A type B	21
Control gears / MCB 10A type B	13

Measured values according to a 277VAC reference power grid as defined under NEMA 410 standard, with a line impedance of 450mΩ / 100uH.

The inrush current values and the number of control gears to be connected to a circuit breaker depend on the mains voltage and mains impedance. It is highly recommended to check it for each installation.

Leakage current and RCDs

Typical touch current	< 0,2 mA peak
Typical earth conductor current	< 0,5 mA rms
Typical control gears / RCD 30mA	35

Typical values for the control gears according to EN 61347-1, not including other components contribution

MECHANICAL FEATURES

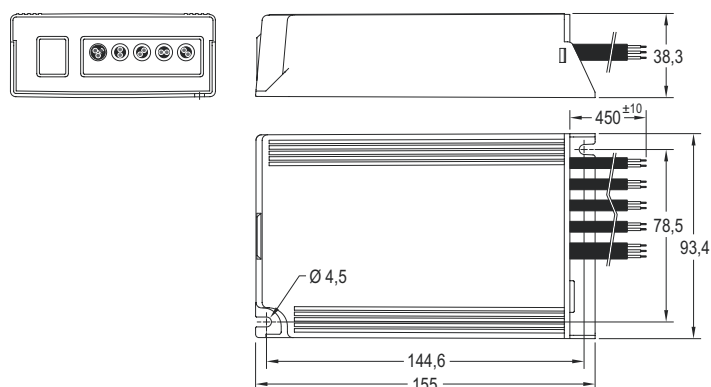

Length	155 mm
Width	93,4 mm
Height	38,3 mm
Distance between fixings (lengthwise)	144,6 mm
Distance between fixings (widthwise)	78,5 mm
Fixing hole diameter	4,5 mm
Design	Compact
Material	Plastic
Weight	975 g
Ingress Protection	IP67

LOGISTICAL DATA

Ref. No.	9916157
Model	iLC PRO 40/200...1050-XT-IP67
Compatible version with STELARIA™ Remote wireless management system	🕒

Packaging

Units per package	8 units
Package dimensions	220 x 430 x 125 mm
Package weight	7,96 kg
Units per pallet	336 units
Pallet dimensions	750 x 1000 mm

🕒 Available upon request. Please consult our Commercial Department

ACCORDING TO

- EN 60598-1
- EN 61347-1
- EN 61347-2-13
- EN 62384
- EN 62493
- EN 61000-3-2
- EN 61000-3-3
- EN 55015
- EN 61547
- EN 62386-101
- EN 62386-102
- EN 62386-207

Please, contact us by email (elt@elt.es), telephone +34 976 573 660 or via our sales network to consult the versions of the above standards under which the certificates have been issue.

APPROVALS

CB / ENEC / CE



ACCESSORIES

iSOFT: configuration software



Follow this link for free download:
www.elt.es/en/download-isoft-software

iProgrammer: configuration interface



Ref. No: 3512003

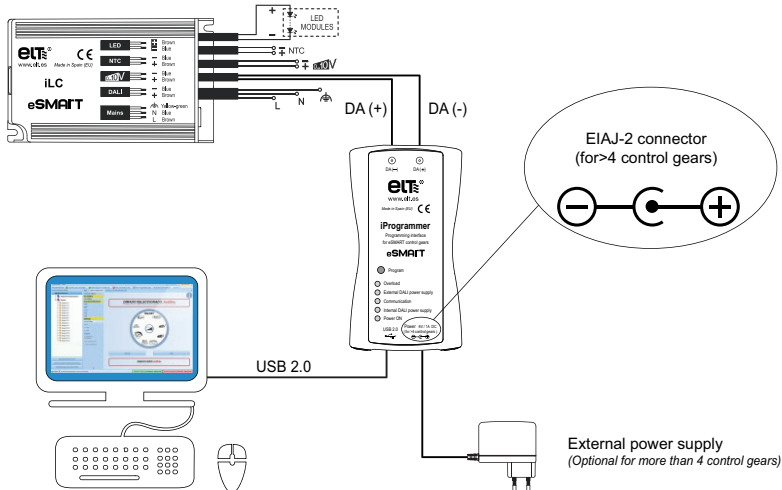

ADDITIONAL INFORMATION

The following information is available to check at www.elt.es/en

- eSMART technology user guide
- IP67 user guide
- Control gear catalogue sheet
- iProgrammer catalogue sheet
- iSOFT manual
- iSOFT software
- eSMART technology site
- STELARIA site
- LED catalogue

DISCLAIMER

This datasheet cancels and replaces all previous versions.

ELT reserves the right without prior notice to make changes to the data and information contained in this datasheet, to the features of the product itself to which the datasheet refers and/or to cease manufacturing and/or commercialising the said product. ELT accepts no liability for any damage arising from the use of this datasheet or the use of the product to which it refers, beyond that explicitly established in the contract.

ELT has taken the utmost care in the drafting of this datasheet and the information and data contained herein has been revised with all due diligence. Nevertheless, the appearance of editorial errors may not be ruled out, in respect of which ELT shall in no event be held liable. The reader is kindly requested to notify ELT of any error identified in this datasheet.

ELT has provided all the information and data contained in this datasheet to the best of its knowledge and understanding, however this information and data in no event constitutes a guarantee, beyond that established by law. ELT expressly disclaims any commitment or liability based on the data and information contained in the datasheet and the individuals responsible for the end product may not consider themselves released from the requirement to undertake their own tests and verifications.

The recommendations included in the datasheet are based on the experience of ELT, but this does not guarantee that they are the best-known technical or commercial options. ELT accepts no claim based on any damage arising from the application of the above recommendations.

The data contained in this datasheet that refer to technical features and product testing are for information purposes only and are not considered to be official certifications that support the release of the end product into which the product the object of this datasheet is to be assembled. The manufacturer of the end product is responsible for testing the product in an accredited laboratory with a view to demonstrating compliance with the legal standards required by the end product in its place of installation, as well as the necessary requirements for every label displayed on the end product (such as CE, ENEC, etc).

The product described in this datasheet is classified as "independent lamp control device" and it has been designed to be installed separately, outside the luminaire, with a protection corresponding to its marking and without additional covering.

The rest of the data and characteristics indicated in this datasheet may be affected by the final product to which it is connected.

ELT accepts no liability for damage arising from the adverse effects that the configuration of the end product may cause to the data and features of the product mentioned in this datasheet.

ELT accepts no liability for possible unforeseen and adverse effects that may occur because of the interaction of the product the object of this datasheet with any other product that forms part of the assembly of the end product, whether manufactured or not by ELT.

ELT kindly requests the user of the datasheet to ensure they are using the most up-to-date documentation and review its content when placing orders or using the product covered by this datasheet. The most recent approved version of our product datasheets can be found on our web page www.elt.es.